



H 377 Serie SL Duemilasedici

Design
Steve Leung

Materiale Ottone
Material Brass

Dimensioni Sizes	Codice Code	Finitura Finish	EAN R8	EAN R7	EAN RG8	
---------------------	----------------	--------------------	--------	--------	---------	--

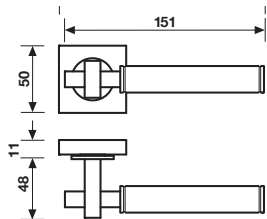

H 377 R8

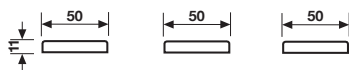
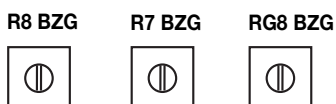
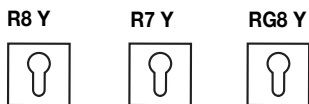
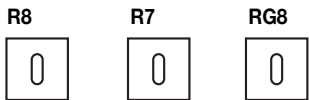

Bronzo scuro	770806	770714	770653	1 coppia/pair
Nero opaco	770813	770721	770660	1 coppia/pair
Titanium	770820	770738	770677	1 coppia/pair

	R8 Y	R7 Y	RG8 Y	
Bronzo scuro	770868	770776	770684	1 coppia/pair
Nero opaco	770875	770783	770691	1 coppia/pair
Titanium	770882	770790	770707	1 coppia/pair

	R8 BZG	R7 BZG	RG8 BZG	
Bronzo scuro	-	770745	770622	1 coppia/pair
Nero opaco	-	770752	770639	1 coppia/pair
Titanium	-	770769	770646	1 coppia/pair

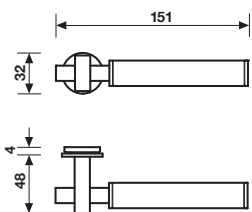

GL8

Bronzo scuro	*	-	-	1 coppia/pair
Nero opaco	*	-	-	1 coppia/pair
Titanium	*	-	-	1 coppia/pair

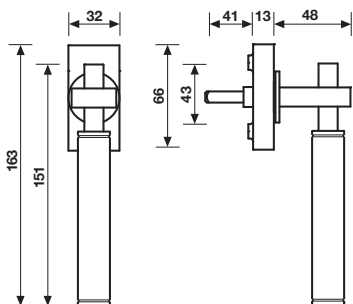

H 377 F RS-41
Movimento
4 scatti
Movement
4 click positions

Bronzo scuro	770899	-	-	2
Nero opaco	770905	-	-	2
Titanium	770912	-	-	2

A richiesta: disponibile il movimento 30-35-45-50 mm
On request: available also for spindle length 30-35-45-50 mm

A richiesta: disponibile il movimento 8 scatti per la microventilazione (solo la misura 41 mm)
On request: available also 8 click positions (only spindle length 41 mm)

* = EAN e prezzo su richiesta
* = EAN code and price on request

- = non disponibile
- = not available







Specifiche spessori porta/lunghezza quadro, pag. 98 del listino
For specifications of door thicknesses and spindle lengths, see price list page 98

In abbinamento
sono disponibili
In combination with

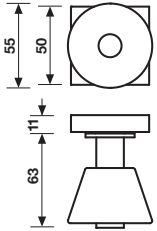
K 377 / K 377 Y
K 377
K 3033 / K 3033 Y
K 3020 R6-7-8 50 BZG - 85

Pomolo per porta / Door knob
Maniglione / Pull Handle
Bocchetta / Escutcheon
Chiusura privacy BZG / Bathroom privacy set

K 377 Serie SL Duemilasedici design Steve Leung

Dimensioni Sizes	Codice Code	Finitura Finish	EAN R8	EAN R7	EAN RG8								
 	R8		R7		RG8		Bronzo scuro	770950	*	*	1 coppia/pair		
							Nero opaco	770967	*	*	1 coppia/pair		
							Titanium	770974	*	*	1 coppia/pair		
									R8 Y	R7 Y	RG8 Y		
		R8 Y		R7 Y		RG8 Y		Bronzo scuro	770981	*	*	1 coppia/pair	
								Nero opaco	770998	*	*	1 coppia/pair	
								Titanium	771001	*	*	1 coppia/pair	

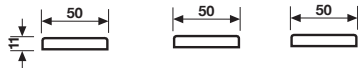

Fissaggi da ordinare a parte
Fixings to be ordered separately

K 377 R8 / K 377 R8 Y

Materiale: Ottone
Material: Brass

K 377 Serie SL Duemilasedici design Steve Leung

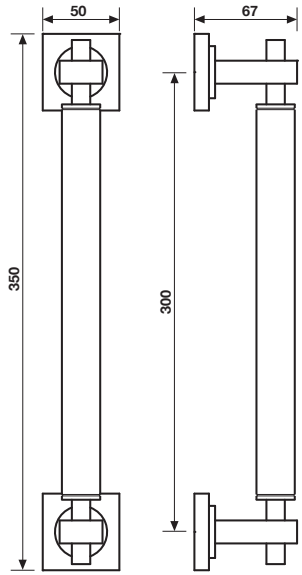
Dimensioni Sizes	Codice Code	Materiale Material	Interasse Centre distance	Finitura Finish	EAN	
 	K 377	Ottone Brass				
			◇◇ 300	Bronzo scuro	770929	1
			◇◇ 300	Nero opaco	770936	1
			◇◇ 300	Titanium	770943	1

NB: possibilità lunghezza personalizzabile. Prezzo da definire per ogni lunghezza.
Lengths can be customized. Price to be determined for each length size.

* = EAN e prezzo su richiesta - = non disponibile Specifiche spessori porta/lunghezza quadro, pag. 98 del listino
* = EAN code and price on request - = not available For specifications of door thicknesses and spindle lengths, see price list page 98