

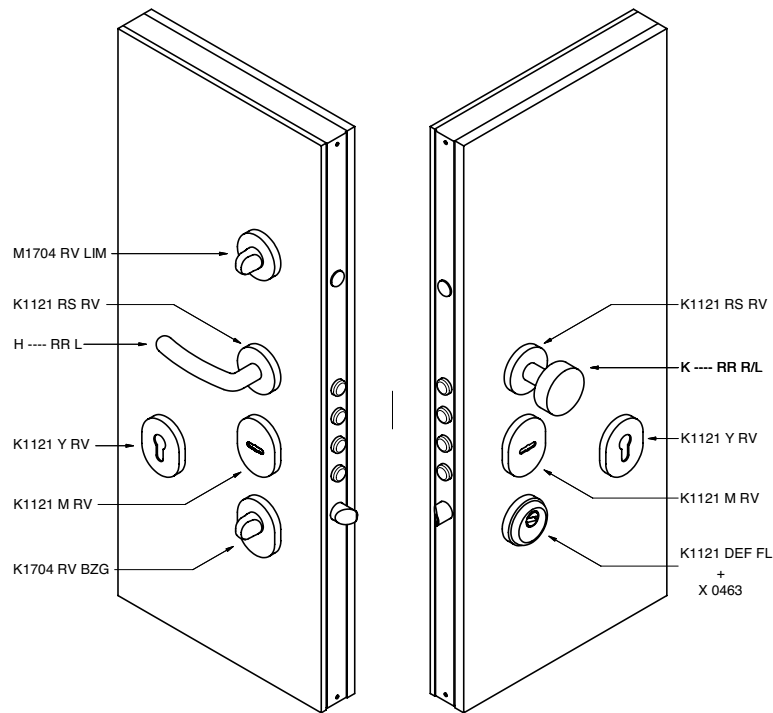

Programma kit porte blindate  
Kits set for security doors

**Versione maniglia / pomolo su rosetta tonda**  
 Version lever handle/knob on round rose



**Versione maniglia / maniglia su rosetta tonda**  
 Version lever handle/lever handle on round rose

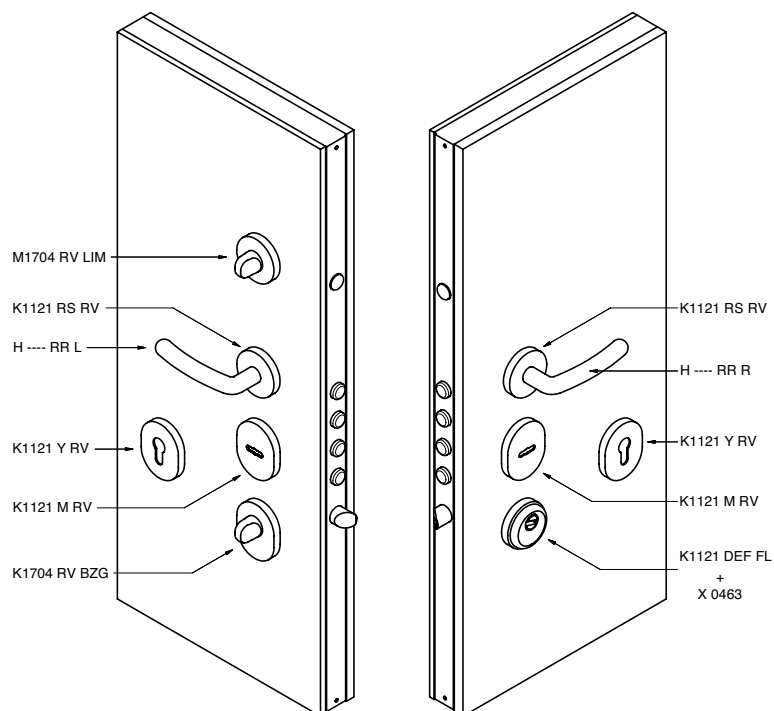

**Versione maniglia / pomolo su rosetta quadra**  
 Version lever handle/knob on square rose

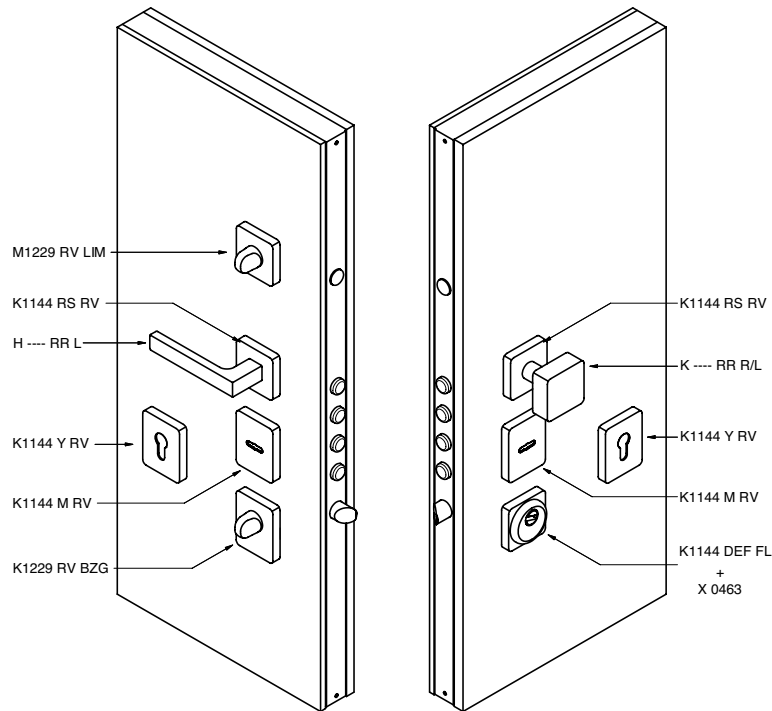

**Versione maniglia / maniglia su rosetta quadra**  
 Version lever handle/lever handle on square rose

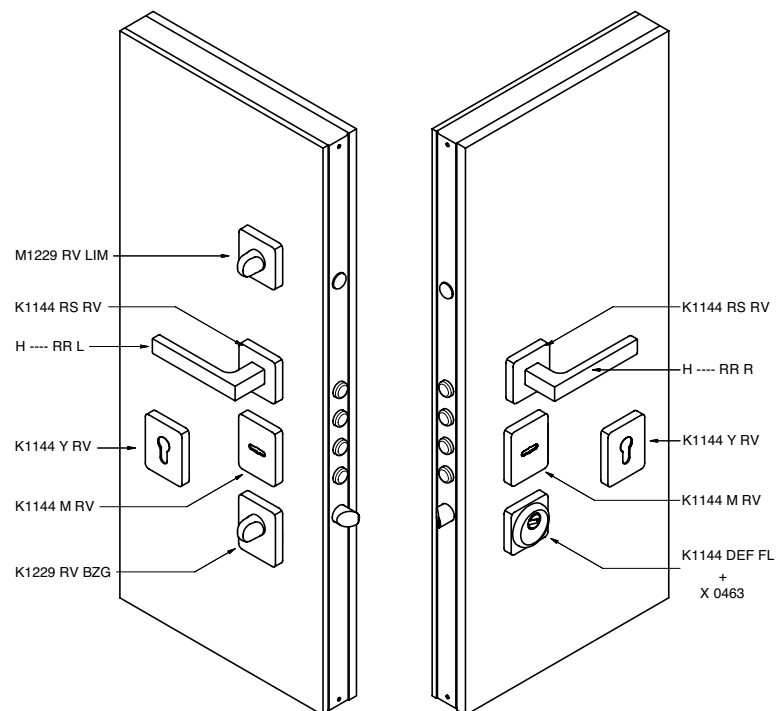

**Maniglie sinistre H RR L**

Left Handles H RR L

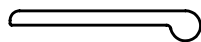

| Codice Code | Finitura Finish      | Codice Code | Finitura Finish |
|-------------|----------------------|-------------|-----------------|
| H 1059 RR L | Oro lucido           | H 198 RR L  | Cromsatin       |
| H 1058 RR L | Cromsatin/Cromo      | H 198 RR L  | Oro lucido      |
| H 1057 RR L | Cromo                | H 195 RR L  | Cromsatin       |
| H 1057 RR L | Oro lucido           | H 195 RR L  | Oro lucido      |
| H 1056 RR L | Cromo                | H 179 RR L  | Oro lucido      |
| H 1055 RR L | Cromo/Nero opaco     | H 174 RR L  | Oro lucido      |
| H 1055 RR L | Cromsatin/Nero opaco | H 165 RR L  | Oro lucido      |
| H 1054 RR L | Cromo                | H 163 RR L  | Cromo           |
| H 1052 RR L | Cromo                | H 163 RR L  | Cromsatin       |
| H 1052 RR L | Cromsatin            | H 163 RR L  | Oro lucido      |
| H 1051 RR L | Cromo                | H 123 RR L  | Oro lucido      |
| H 1051 RR L | Cromsatin            | H 417 RR L  | Cromsatin       |
| H 1050 RR L | Cromo                | H 417 RR L  | Orolux          |
| H 1050 RR L | Cromsatin            | H 412 RR L  | Oro lucido      |
| H 1049 RR L | Cromo                | H 412 RR L  | Cromsatin       |
| H 1049 RR L | Cromsatin            | H 44 RR L   | Orolux          |
| H 1046 RR L | Cromo                | H 44 RR L   | Cromsatin       |
| H 1046 RR L | Cromsatin            |             |                 |
| H 1045 RR L | Cromo                |             |                 |
| H 1045 RR L | Cromsatin            |             |                 |
| H 1044 RR L | Cromo                |             |                 |
| H 1044 RR L | Cromsatin            |             |                 |
| H 1043 RR L | Cromo/Cromsatin      |             |                 |
| H 1043 RR L | Orolux/Satinato      |             |                 |
| H 1042 RR L | Cromo                |             |                 |
| H 1042 RR L | Oro lucido           |             |                 |
| H 1042 RR L | Cromsatin            |             |                 |
| H 1040 RR L | Cromsatin            |             |                 |
| H 1040 RR L | Cromo                |             |                 |
| H 1039 RR L | Cromo/Cromsatin      |             |                 |
| H 1039 RR L | Oro lucido           |             |                 |
| H 1027 RR L | Cromsatin            |             |                 |
| H 1027 RR L | Oro lucido           |             |                 |
| H 1026 RR L | Cromo/Cromsatin      |             |                 |
| H 1026 RR L | Orsatin/Oro lucido   |             |                 |
| H 1024 RR L | Cromo                |             |                 |
| H 1024 RR L | Cromsatin            |             |                 |
| H 1024 RR L | Oro lucido           |             |                 |
| H 1022 RR L | Cromo/Cromsatin      |             |                 |
| H 1022 RR L | Oro lucido/Orsatin   |             |                 |
| H 1018 RR L | Cromo/Cromsatin      |             |                 |
| H 1018 RR L | Oro lucido/Orsatin   |             |                 |
| H 1016 RR L | Cromsatin            |             |                 |
| H 1016 RR L | Oro lucido           |             |                 |
| H 1003 RR L | Cromsatin            |             |                 |
| H 1003 RR L | Oro lucido           |             |                 |

**Maniglie destre H RR R**

Right Handles H RR R

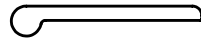

| Codice Code | Finitura Finish      | Codice Code | Finitura Finish |
|-------------|----------------------|-------------|-----------------|
| H 1059 RR R | Oro lucido           | H 198 RR R  | Cromsatin       |
| H 1058 RR R | Cromsatin/Cromo      | H 198 RR R  | Oro lucido      |
| H 1057 RR R | Cromo                | H 195 RR R  | Cromsatin       |
| H 1057 RR R | Oro lucido           | H 195 RR R  | Oro lucido      |
| H 1056 RR R | Cromo                | H 179 RR R  | Oro lucido      |
| H 1055 RR R | Cromo/Nero opaco     | H 174 RR R  | Oro lucido      |
| H 1055 RR R | Cromsatin/Nero opaco | H 165 RR R  | Oro lucido      |
| H 1054 RR R | Cromo                | H 163 RR R  | Cromo           |
| H 1052 RR R | Cromo                | H 163 RR R  | Cromsatin       |
| H 1052 RR R | Cromsatin            | H 163 RR R  | Oro lucido      |
| H 1051 RR R | Cromo                | H 123 RR R  | Oro lucido      |
| H 1051 RR R | Cromsatin            | H 417 RR R  | Cromsatin       |
| H 1050 RR R | Cromo                | H 417 RR R  | Orolux          |
| H 1050 RR R | Cromsatin            | H 412 RR R  | Oro lucido      |
| H 1049 RR R | Cromo                | H 412 RR R  | Cromsatin       |
| H 1049 RR R | Cromsatin            | H 44 RR R   | Orolux          |
| H 1046 RR R | Cromo                | H 44 RR R   | Cromsatin       |
| H 1046 RR R | Cromsatin            |             |                 |
| H 1045 RR R | Cromo                |             |                 |
| H 1045 RR R | Cromsatin            |             |                 |
| H 1044 RR R | Cromo                |             |                 |
| H 1044 RR R | Cromsatin            |             |                 |
| H 1043 RR R | Cromo/Cromsatin      |             |                 |
| H 1043 RR R | Orolux/Satinato      |             |                 |
| H 1042 RR R | Cromo                |             |                 |
| H 1042 RR R | Oro lucido           |             |                 |
| H 1042 RR R | Cromsatin            |             |                 |
| H 1040 RR R | Cromsatin            |             |                 |
| H 1040 RR R | Cromo                |             |                 |
| H 1039 RR R | Cromo/Cromsatin      |             |                 |
| H 1039 RR R | Oro lucido           |             |                 |
| H 1027 RR R | Cromsatin            |             |                 |
| H 1027 RR R | Oro lucido           |             |                 |
| H 1026 RR R | Cromo/Cromsatin      |             |                 |
| H 1026 RR R | Orsatin/Oro lucido   |             |                 |
| H 1024 RR R | Cromo                |             |                 |
| H 1024 RR R | Cromsatin            |             |                 |
| H 1024 RR R | Oro lucido           |             |                 |
| H 1022 RR R | Cromo/Cromsatin      |             |                 |
| H 1022 RR R | Oro lucido/Orsatin   |             |                 |
| H 1018 RR R | Cromo/Cromsatin      |             |                 |
| H 1018 RR R | Oro lucido/Orsatin   |             |                 |
| H 1016 RR R | Cromsatin            |             |                 |
| H 1016 RR R | Oro lucido           |             |                 |
| H 1003 RR R | Cromsatin            |             |                 |
| H 1003 RR R | Oro lucido           |             |                 |

## K 1171 RR R/L

**Pomolo centrale quadrato girevole o fisso**  
Square central knob turning or fixed

**Materiale Alluminio**  
Material Aluminium

**Finiture / Finishes**  
Cromo  
Cromsatin

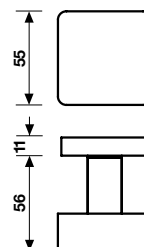

## K 1170 RR R/L

**Pomolo centrale tondo girevole o fisso**  
Round central knob turning or fixed

**Materiale Alluminio**  
Material Aluminium

**Finiture / Finishes**  
Cromo  
Cromsatin  
Zirtanio oro lucido (Ottone)

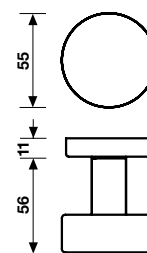

## K 1166

**Pomolo centrale tondo solo fisso**  
Fixed central knob

**Materiale Nikrall Lega Zama UNI 3717**  
Material Nikrall Lega Zama UNI 3717

**Finiture / Finishes**  
Cromo  
Cromsatin  
Zirtanio oro lucido

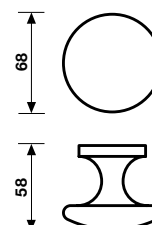

# K 1121 RS RV

## Rosetta tonda

Round rose

### Materiale Ottone

Material Brass

### Finiture / Finishes

Cromo  
Cromsatin  
Oro lucido

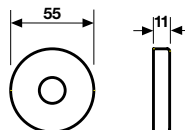

# M 1704 RV LIM

## Limitatore apertura su rosetta tonda

Safety catch on round rose

### Materiale Ottone

Material Brass

### Finiture / Finishes

Cromo  
Cromsatin  
Oro lucido

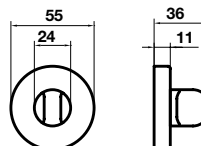

# K 1704 RV BZG

## Nottolino per cilindro su rosetta ovale

Thumbturn for cylinder on oval rose

### Materiale Material

Nikrall Lega Zama  
UNI 3717

### Finiture / Finishes

Cromo  
Cromsatin  
Orolux

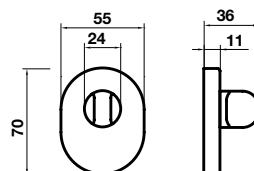

# K 1121 Y RV

## Bocchetta ovale foro cilindro

Oval cylinder escutcheon

### Materiale Material

Nikrall Lega Zama  
UNI 3717

### Finiture / Finishes

Cromo  
Cromsatin  
Orolux

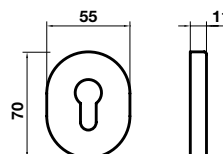

# K 1121 M RV

## Bocchetta ovale foro doppia mappa

Double bit lock hole oval escutcheon

### Materiale Material

Nikrall Lega Zama  
UNI 3717

### Finiture / Finishes

Cromo  
Cromsatin  
Orolux

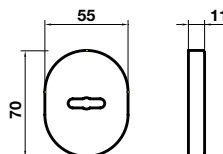

# K 1121 DEF FL

## Rosetta tonda per defender

Defender round rose

### Materiale Ottone

Material Brass

### Finiture / Finishes

Cromo  
Cromsatin  
Oro lucido

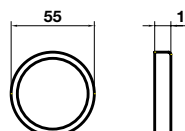

# K 1144 RS RV

## Rosetta quadra

Square rose

**Materiale** Material  
Nikrall Lega Zama  
UNI 3717

**Finiture** / Finishes  
Cromo  
Cromsatin

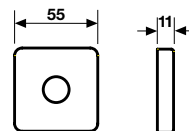

# M 1229 RV LIM

## Limitatore apertura su rosetta quadra

Safety catch on square rose

**Materiale** Material  
Nikrall Lega Zama  
UNI 3717

**Finiture** / Finishes  
Cromo  
Cromsatin

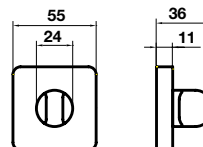

# K 1229 RV BZG

## Nottolino per cilindro su rosetta rettangolare

Thumbturn for cylinder on rectangular rose

**Materiale** Material  
Nikrall Lega Zama  
UNI 3717

**Finiture** / Finishes  
Cromo  
Cromsatin

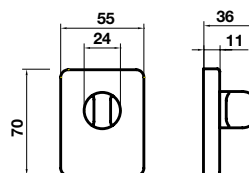

# K 1144 Y RV

## Bocchetta rettangolare foro cilindro

Rectangular cylinder escutcheon

**Materiale** Material  
Nikrall Lega Zama  
UNI 3717

**Finiture** / Finishes  
Cromo  
Cromsatin

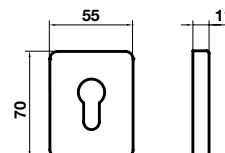

# K 1144 M RV

## Bocchetta rettangolare foro doppia mappa

Double bit lock hole rectangular escutcheon

**Materiale** Material  
Nikrall Lega Zama  
UNI 3717

**Finiture** / Finishes  
Cromo  
Cromsatin

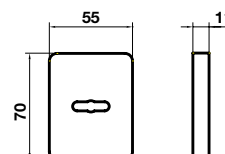

# K 1144 DEF FL

## Rosetta quadra per defender

Defender square rose

**Materiale** Material  
Nikrall Lega Zama  
UNI 3717

**Finiture** / Finishes  
Cromo  
Cromsatin

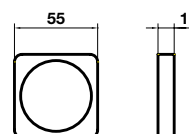

# X 0468/1

**Sottorosetta per Porte Blindate con molla monodirezionale destra, diametro 50 mm, completa di viti per il fissaggio e bussola di centratura**

Backplate for security doors with righthand monodirectional spring 50 mm diameter complete of fixing screws and centering sleeve

**Materiale** Material  
Nikrall Lega Zama UNI  
3717

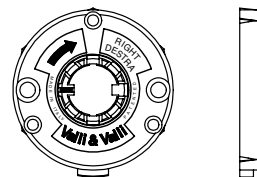

# X 0468/2

**Sottorosetta per Porte Blindate con molla monodirezionale sinistra, diametro 50 mm, completa di viti per il fissaggio e bussola di centratura**

Backplate for security doors with lefthand monodirectional spring 50 mm diameter complete of fixing screws and centering sleeve

**Materiale** Material  
Nikrall Lega Zama UNI  
3717

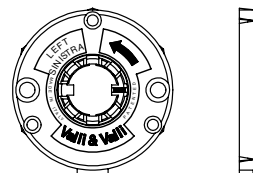

# X 0468/3

**Sottorosetta per Porte Blindate senza molla, diametro 50 mm, completa di viti per il fissaggio e bussola di centratura**

Backplate for security doors without spring 50mm.diameter complete of fixing screws and centering sleeve

**Materiale** Material  
Nikrall Lega Zama UNI  
3717

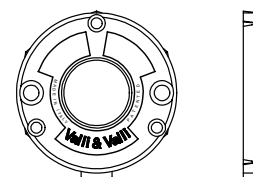

# X 0463

**Defender Ø46 mm**

**Finiture / Finishes**

Cromo  
Cromsatin  
Zirtanio oro lucido

**Materiale** Acciaio ad alta  
resistenza temprato e zincato  
Material High resistant steel  
hardened and galvanized

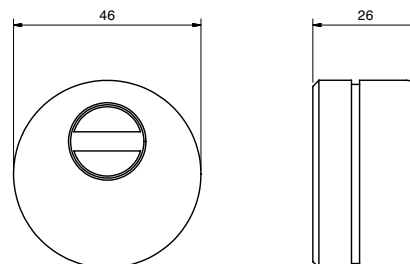

# X 0519

**Per fissaggio pomolo fisso su serratura in coppia con maniglia. Utilizzo di quadro solidale a piastrina**

For a back-to back mounting on lock of a fixed knob with a door handle by using a taylor spindle

**Materiale** Acciaio  
Material Steel

